

Loss Analysis of Single-Mode Fiber Splices

By D. MARCUSE

(Manuscript received November 10, 1976)

This paper analyses losses caused by the misalignment of two fibers joined in a splice. We consider the possibility that the two fibers of different dimensions are separated in longitudinal direction and are tilted or offset with respect to each other. Central to our discussion is the observation that the modes of single-mode fibers are very nearly gaussian in shape regardless of the fiber type—step-index or graded-index. The splice losses are thus related to the corresponding losses of gaussian beams. We specify the relation between the actual mode field and the gaussian beam that matches this field optimally. The trade-off between splice tolerances with respect to tilt and offset is expressed as an "uncertainty principle." Because of the near-gaussian nature of single-mode fiber fields, our results are immediately applicable to the excitation of single-mode fibers by gaussian-shaped laser beams.

I. INTRODUCTION

Light transmission losses of single-mode fiber splices depend on the alignment accuracy of the fiber ends relative to each other.¹ We assume that the fibers are immersed in index-matching fluid to minimize reflection losses at the fiber ends. Most troublesome are transverse misalignments (offsets) and angular misalignments (tilts). Fiber splices are surprisingly tolerant of longitudinal misalignment.

We begin our discussion by showing that the fields of single-mode, step-index fibers are very nearly gaussian in shape. This observation holds with even more assurance for parabolic-index fibers, because the modes of the infinitely extended parabolic-index medium are themselves gaussian and are changed only slightly by the truncation of the index profile at the core boundary. Once it is established that fiber modes may be closely approximated by gaussian field distributions, the evaluation of splice losses reduces to the computation of transmission losses between misaligned gaussian beams.^{2,3}

We present formulas for relating the width of the gaussian field distribution to the fiber parameters. An implicit relation for all types of

fibers is given and explicit formulas are derived for the important cases of step-index and parabolic-index fibers. Next, we present simple analytical expressions for the transmission coefficient of fiber splices for the case of longitudinal, transverse, and angular misalignment for fibers of different dimensions.

Transverse splice tolerances become less stringent for fibers whose mode fields extend farther in transverse directions. Wide mode fields can be obtained by selecting a core index that is very nearly equal to the refractive index of the cladding. However, a wide fiber mode is less tolerant of angular misalignments. The relative tolerance of fiber splices with respect to offsets and tilts is expressed as an "uncertainty principle."

We limit our discussion to "weakly guiding" fibers⁴ defined by the relation $n_1/n_2 - 1 \ll 1$, where n_1 is the maximum value of the refractive index of the fiber core and n_2 is the value of the cladding index. The transmission coefficient of weakly guiding fiber modes can be obtained by matching only the transverse components of the electric field vector of the two modes; their transverse magnetic field components are automatically matched approximately. We designate the electric field vectors of the modes (guided and radiation modes) of the fiber by the symbol \mathbf{E}_ν . The incident electric field \mathbf{E} at the input end of the fiber can then be expressed in terms of fiber modes as follows⁵:

$$\mathbf{E} = \sum_{\nu} c_{\nu} \mathbf{E}_{\nu}. \quad (1)$$

The summation symbol indicates symbolically summation over guided modes (only one for single-mode fibers) and integration over radiation modes. The symbol ν labels the modes (we use $\nu = 0$ as the label of the guided mode of the single-mode fiber). Mode orthogonality allows us to obtain c_0 from (1),

$$c_0 = \frac{1}{2P} \int_0^{2\pi} d\phi \int_0^{\infty} (\mathbf{E} \times \mathbf{H}_0) \cdot \mathbf{e}_z r dr. \quad (2)$$

\mathbf{H}_0 is the magnetic-field vector of the guided mode, \mathbf{e}_z is a unit vector in the direction of the fiber axis, and r and ϕ are cylindrical coordinates in the plane at right angles to the axis of the fiber. We assume that the fiber is receiving radiation from either an input fiber at a splice or from a free-space gaussian laser beam. Correspondingly, \mathbf{E} represents the field that the first fiber of the splice generates at the input end of the second fiber or, alternatively, the gaussian beam mode of a laser.

The power transmission coefficient, finally, is obtained from (2) by the relation,

$$T = |c_0|^2. \quad (3)$$

II. REPRESENTATION OF THE FIBER MODE AS A GAUSSIAN BEAM

The guided modes of weakly guiding fibers are very nearly transverse and linearly polarized.⁴ The electric field vector of the input field consists likewise of one dominant transverse component.³ Let us assume that the input field is gaussian

$$E_y = [4\sqrt{\mu_0/\epsilon_0} P/\pi n_2 w^2]^{1/2} \exp\left(-\frac{r^2}{w^2}\right) e^{-i\beta z}. \quad (4)$$

The refractive index n_2 equals the cladding index of the fiber, P is the power carried by the field and is identical to the P parameter in (2), w is the width parameter of the gaussian field, β is its propagation constant, μ_0 and ϵ_0 are the magnetic susceptibility and the dielectric permittivity of vacuum.

We wish to compare the gaussian field to the mode of the step-index fiber,⁵

$$\mathbf{H}_{x0} = -\sqrt{\frac{2}{\pi}} \left(\frac{\epsilon_0}{\mu_0}\right)^{1/4} \frac{W}{a V J_1(U)} \sqrt{n_2 P} \begin{cases} J_0\left(U \frac{r}{a}\right) & r \leq a \\ \frac{J_0(U)}{K_0(W)} K_0\left(W \frac{r}{a}\right) & r \geq a. \end{cases} \quad (5)$$

The P parameter is identical to those in (2) and (4), W and U are related to the important V parameter by the equation,

$$U^2 + W^2 = V^2 = (n_1^2 - n_2^2) k^2 a^2. \quad (6)$$

The free space propagation constant of plane waves is $k = 2\pi/\lambda$ and a is the core radius of the fiber. J_0 and J_1 are Bessel functions and K_0 is the modified Hankel function. The parameter U can be related to the propagation constant β_s [omitted from (5)] as follows:

$$U = (n_1^2 k^2 - \beta_s^2)^{1/2} a. \quad (7)$$

By substitution of (4) and (5) into (2) and (3), we obtain the transmission coefficient of a gaussian input beam exciting the HE_{11} mode of a fiber. The r -integral in (2) must be evaluated numerically. It is clear that the value of T depends on the width parameter w of the gaussian beam; T assumes a maximum as a function of w . The maximum value of T is plotted as a function of V in Fig. 1. It is remarkable how closely T approaches unity over the range of V -values shown in the figure. At the important point $V = 2.4$, we have $T = 0.9965$. $V = 2.4$ is close to the largest value at which the fiber supports only one mode. The next higher mode comes in at $V = 2.405$. It is apparent that at $V = 2.4$ the field distribution of the fiber mode matches the gaussian field almost perfectly. The best match is achievable at $V = 2.8$; T decreases very slowly for larger values of V . For smaller V -values, the decrease and consequently

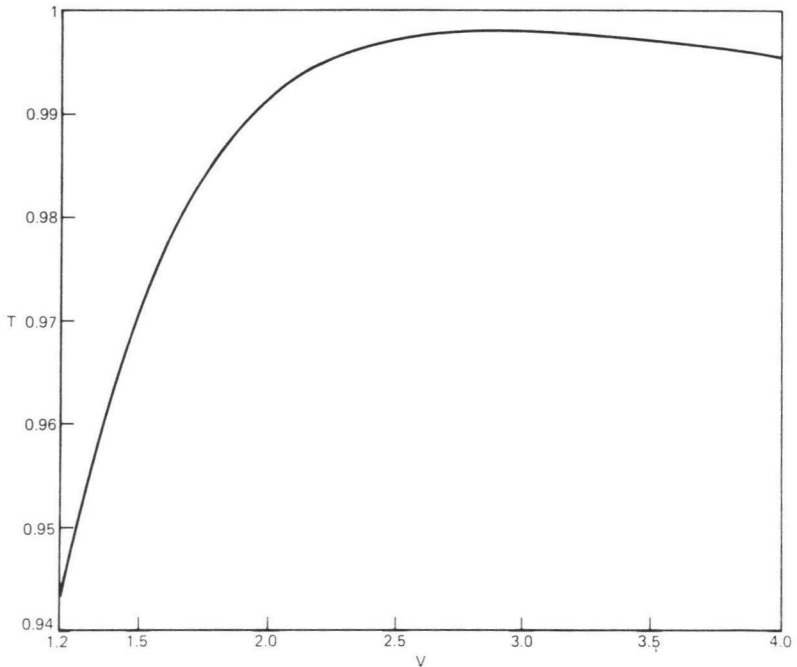

Fig. 1—Maximum value of transmission coefficient between a perfectly aligned and optimally adjusted gaussian beam and a single-mode step-index fiber.

the mismatch between gaussian field and fiber mode is more pronounced; but even at $V = 1.2$, we have $T = 0.946$, a value very close to unity so that, even for such small values of V , the gaussian beam is a reasonably good approximation of the fiber mode. It can be shown that the optimum value of w divided by the core radius is only a function of V . Figures 2 and 3 show the optimum values of w/a as a function of V as the solid line. This function can be approximated very closely (to within a fraction of 1 percent) by the empirical formula,

$$\frac{w}{a} = 0.65 + \frac{1.619}{V^{3/2}} + \frac{2.879}{V^6}. \quad (8)$$

This equation holds, of course, only for step-index fibers. The meaning of the dotted curve in Fig. 2 will be explained later.

It is desirable to have similar relations for graded-index fibers because this would enable us to predict their splice losses. The fields of general graded-index fibers are not known explicitly, so that we cannot use eqs. (2) through (4) to optimize the width of the corresponding gaussian beams. However, we can use a different approach. If we insist that (4) should be used to approximate the guided mode of a single-mode fiber with refractive index distribution $n(r)$ for $r < a$ and $n(r) = n_2$ for $r > a$,

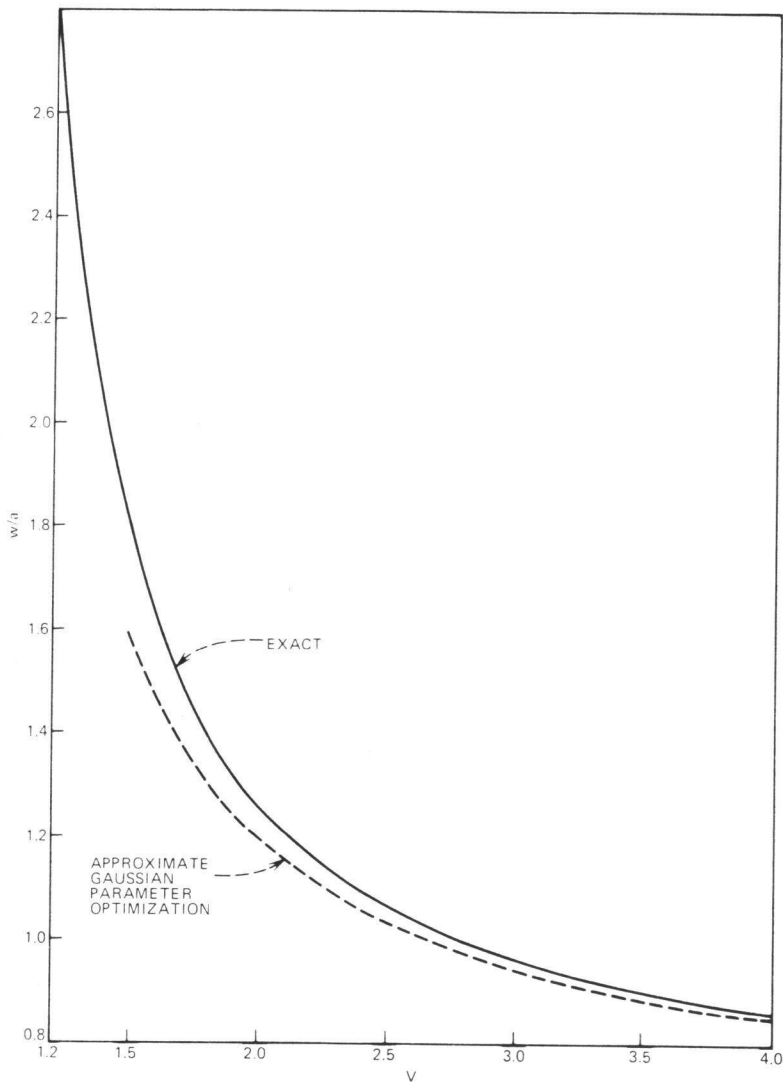

Fig. 2—Normalized optimum width parameter w/a as a function of the V -parameter for step-index fibers. The dotted line is obtained from the approximate procedure expressed in eqs. (19) and (20).

we may substitute (4) into the wave equation

$$\frac{d^2 E_y}{dr^2} + \frac{1}{r} \frac{dE_y}{dr} + [n^2(r)k^2 - \beta^2] E_y = 0, \quad (9)$$

and obtain

$$\left\{ \frac{4}{w^2} \left(\frac{r^2}{w^2} - 1 \right) + n^2(r)k^2 - \beta^2 \right\} E_y = 0. \quad (10)$$

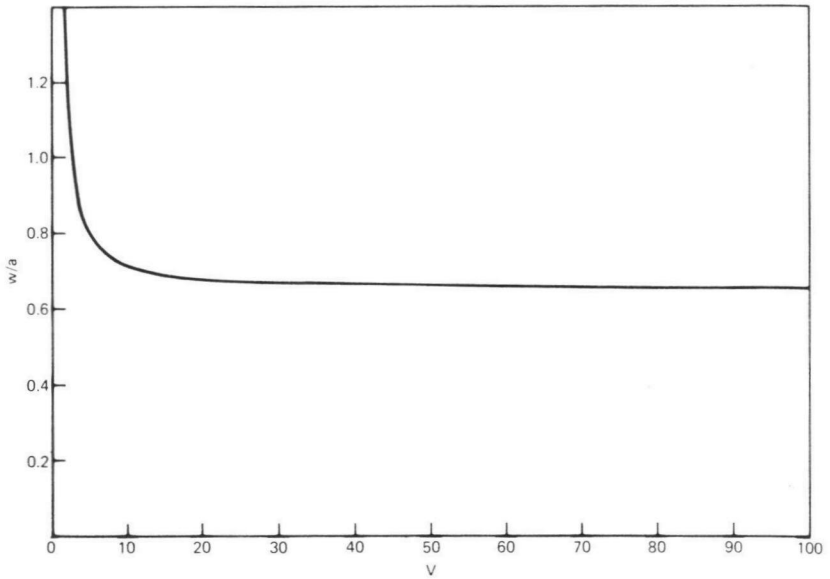

Fig. 3—Same as Fig. 2 for wider range of V -values.

For a graded-index distribution,

$$n(r) = n_1 \left[1 - \left(\frac{r}{a} \right)^g \Delta \right] \quad (11)$$

with $g = 2$, (10) can be satisfied exactly. Note that (11) is an infinitely extended parabolic-index profile. In this case, we find

$$w = \sqrt{\frac{2}{V}} a \quad (12)$$

and

$$\beta = [n_1^2 k^2 - 2V/a^2]^{1/2}. \quad (13)$$

We define the V -parameter for any value of g by the equation

$$V = n_1 k a \sqrt{2\Delta}. \quad (14)$$

This expression is also a good approximation of (6), if we use

$$\Delta = 1 - \frac{n_2}{n_1} \ll 1. \quad (15)$$

Equations (12) and (13) are not correct for actual parabolic-index fibers whose refractive index distributions are given by (11) (with $g = 2$) only for $r < a$, but assume the form $n(r) = n_2$ for $r > a$. We refer to profiles of this kind as truncated index distributions.

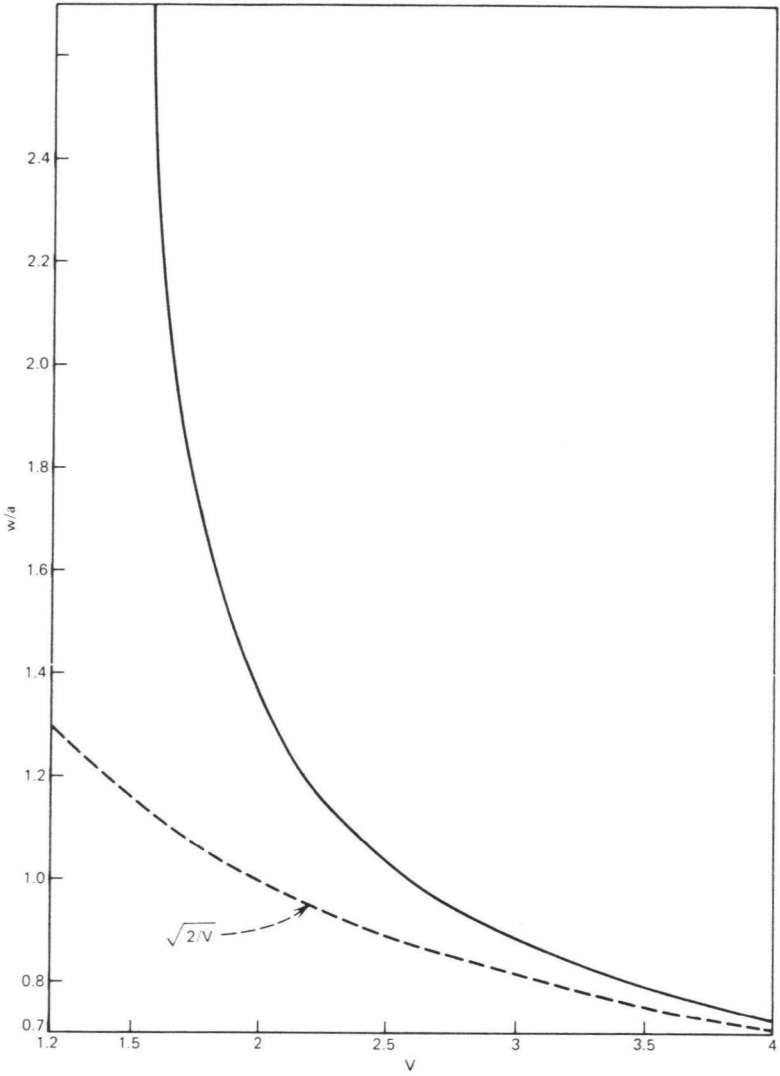

Fig. 4—Normalized optimum beam width w as a function of V for the parabolic-index fiber. The dotted line applies to an infinitely extended parabolic-index profile.

of the accuracy of the method for other values of g are harder to make since the exact field distributions are hard to obtain; no attempts were made to evaluate the performance of the parameter optimization procedure for smaller values of g . However, there is little doubt that the results for values near $g = 2$ will be much better than the comparison shown in Fig. 2.

Figure 4 shows the numerical solution of (19) and (20) for the trun-

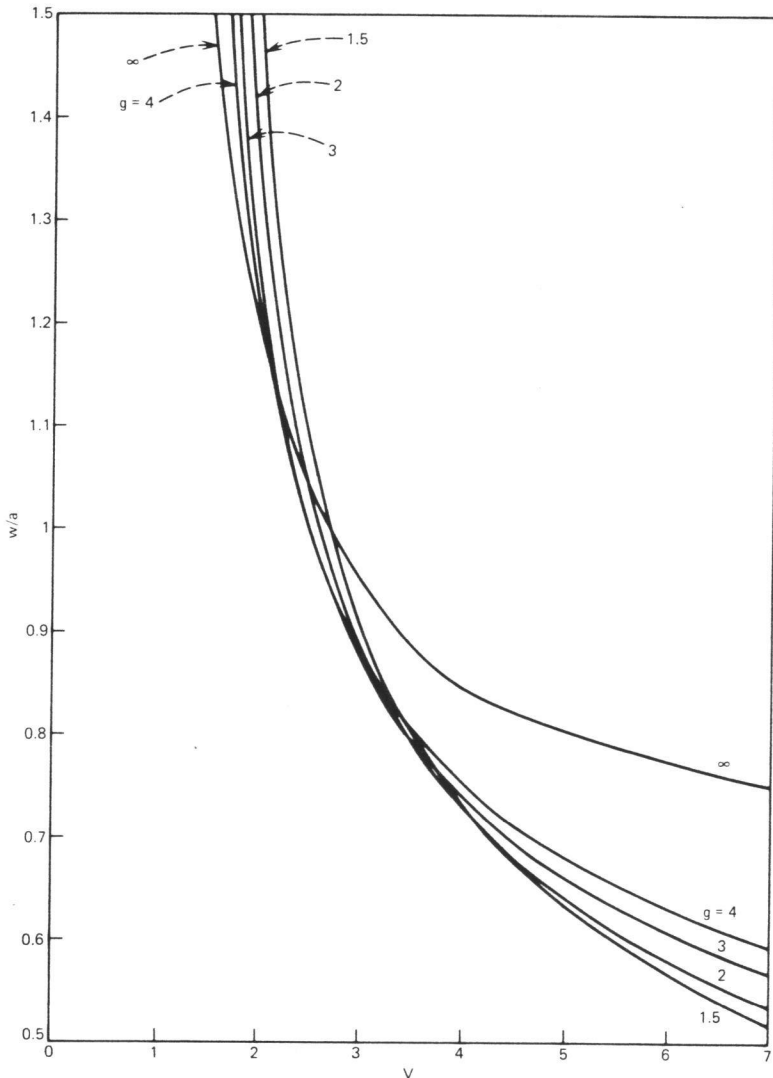

Fig. 5— w/a as a function of V for several values of the power law parameter g defined by (11).

cated parabolic-index profile—that is, for $n(r)$ given by (11) with $g = 2$ for $r < a$ and by $n(r) = n_2$ for $r > a$. The dotted line shown in Fig. 4 applies to the infinitely extended parabolic-index profile and represents the solution (12). It is clear that the field distribution of the truncated parabolic-index profile is wider than the field of the infinitely extended profile because that part of the field that extends into the cladding is no longer under the focusing influence of the graded-index distribution.

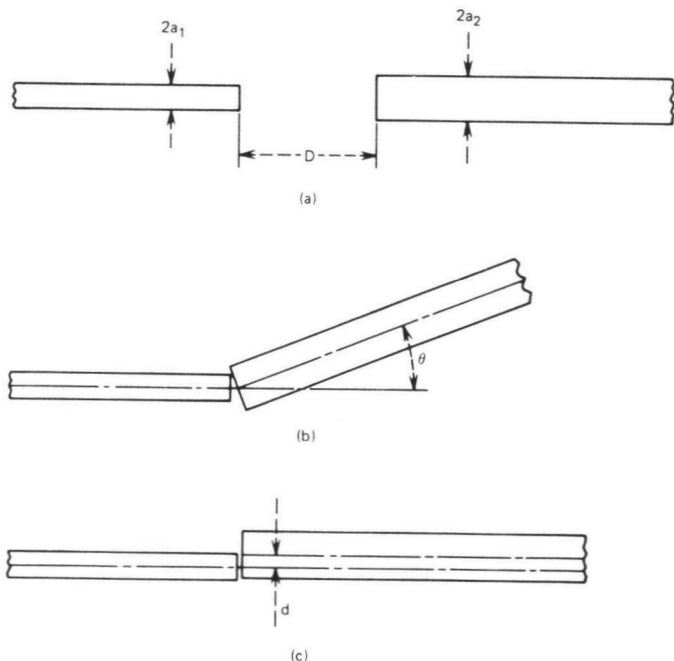

Fig. 6—Several types of splice imperfections.

For large V values both curves coincide; at $V = 5$ the difference of the two curves is already reduced to 1 percent. The solid line in Fig. 4 can be expressed by the empirical approximation

$$\frac{w}{a} = \sqrt{\frac{2}{V}} + \frac{0.23}{V^{3/2}} + \frac{18.01}{V^6}. \quad (21)$$

This equation gives the optimum width of the gaussian field profile that best approximates the actual field distribution of a parabolic-index fiber.

Figure 6 shows the optimum width w/a computed from (19) and (20) for truncated graded-index profiles for several values of the exponent g appearing in (11).

III. SPLICE LOSSES

Henceforth, we represent the fields of single-mode fibers by gaussian field distributions of the form (4) keeping in mind that the optimum width parameters w of the gaussian can be obtained as solutions of (19) and (20) for general graded-index fibers, or, explicitly, by (8) or (21) for step-index and parabolic-index fibers.

The different types of splice defects are shown in Fig. 6. We allow both fibers joined by the splice to have different parameters shown as different

core diameters in Fig. 6. The actual differences may consist of different refractive index distributions as well as different core diameters. For our analysis, each fiber is represented by the width parameter of the optimum gaussian field distribution, w_1 belongs to the fiber with radius a_1 , and w_2 belongs to the fiber with a_2 .

The relevant formulas can all be derived by using (2) and (3) with the fields of both fibers represented by gaussian field distributions of the form (4). The E field in (3) is understood to be the gaussian field of the first fiber transformed to the input plane of the second fiber. Such mode matching calculations involving gaussian fields are not new, we present here only the results.^{2,3}

3.1 Longitudinal fiber separation

For the splice shown in Fig. 6a, we find the power transmission coefficient

$$T = \frac{4 \left[4Z^2 + \frac{w_1^2}{w_2^2} \right]}{\left[4Z^2 + \frac{w_2^2 + w_1^2}{w_2^2} \right]^2 + 4Z^2 \frac{w_2^2}{w_1^2}}. \quad (22)$$

The normalized fiber separation distance is defined as

$$Z = \frac{D}{n_2 k w_1 w_2}. \quad (23)$$

Two special cases are of interest. At $D = 0$, we have

$$T_0 = \left(\frac{2w_1 w_2}{w_1^2 + w_2^2} \right)^2. \quad (24)$$

For $D \rightarrow \infty$, we obtain asymptotically

$$T_\infty = \frac{1}{Z^2} = \left(\frac{n_2 k w_1 w_2}{D} \right)^2. \quad (25)$$

3.2 Splices with tilt

For the fiber tilt shown in Fig. 6b, we obtain the power transmission coefficient

$$T = \left(\frac{2w_1 w_2}{w_1^2 + w_2^2} \right)^2 \exp \left[- \frac{2(\pi n_2 w_1 w_2 \theta)^2}{(w_1^2 + w_2^2) \lambda^2} \right]. \quad (26)$$

When the tilt angle θ becomes large enough to make the exponent of the exponential function in (26) unity, the transmitted power decreases to

1/e of its maximum value. This angle is given by the expression,

$$\theta_e = \left(\frac{w_1^2 + w_2^2}{2} \right)^{1/2} \frac{\lambda}{\pi n_2 w_1 w_2}. \quad (27)$$

3.3 Splices with fiber offset

The power transmission coefficient through the fiber splice shown in Fig. 6c assumes the form

$$T = \left(\frac{2w_1 w_2}{w_1^2 + w_2^2} \right)^2 \exp \left[-\frac{2d^2}{w_1^2 + w_2^2} \right]. \quad (28)$$

The amount of offset that reduces the transmitted power to 1/e of its maximum value can be defined as

$$d_e = \left(\frac{w_1^2 + w_2^2}{2} \right)^{1/2}. \quad (29)$$

For identical fibers with $w_1 = w_2$, we obtain a very useful and interesting relation by combining (27) and (29)

$$d_e \theta_e = \frac{\lambda}{n_2 \pi}. \quad (30)$$

This expression is reminiscent of the uncertainty principle of quantum mechanics, because it states that as one of two variables becomes smaller, the other must become larger. If a single-mode fiber is designed with a small value of Δ , to allow the field to spread out in transverse direction, w becomes large and, consequently, d_e may be large indicating that a large offset can be tolerated. Equation (30) states that for large values of d_e the tilt angle tolerance decreases. A fiber that is tolerant of large offsets is intolerant with respect to tilts and vice versa.

IV. DISCUSSION AND NUMERICAL EXAMPLES

Throughout our discussion, we are using the width parameter w of the field distribution (4). Experimental observations of the light field of a single-mode fiber detect the light power instead of the field intensity. The power may also be approximated by a gaussian distribution of the form

$$P = P_0 \exp(-r^2/w_p^2). \quad (31)$$

The power width parameter w_p is related to the field intensity width parameter w by the expression

$$w_p = \frac{w}{\sqrt{2}}. \quad (32)$$

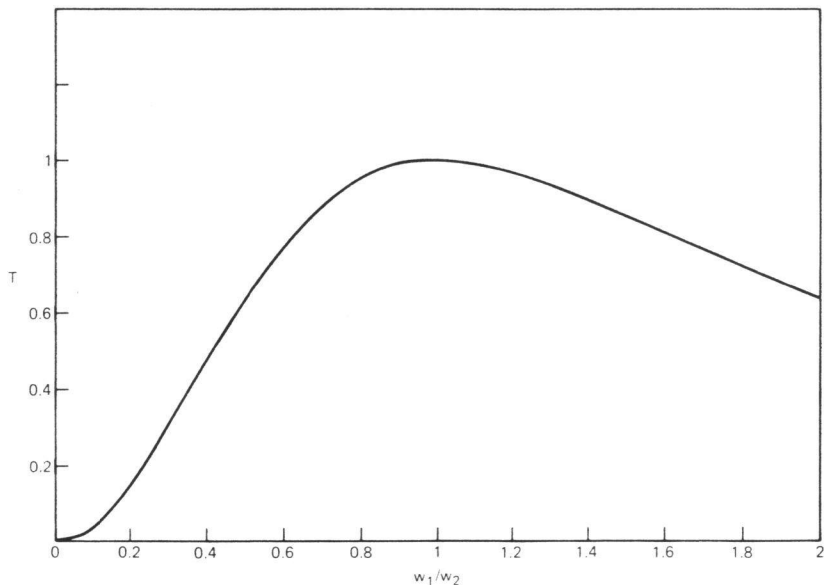

Fig. 7—Power transmission coefficient T as a function of the ratio w_1/w_2 of the beam width parameters of the two fibers joined by a perfectly aligned splice.

This relation is important if the width of the mode field is known from measurements instead of being inferred from the known V -value of the fiber.

We begin our discussion of splice losses by considering two perfectly aligned fibers with different dimensions. Figure 7 shows a plot of the power transmission coefficient T as a function of w_1/w_2 . This function is, of course, identical if plotted versus w_2/w_1 . A ratio $w_1/w_2 = 1.4$ (or 0.71) causes a power loss of 10 percent. If we assume that we are dealing with step-index fibers, we see from Fig. 2 that a reduction of the V -value from $V = 2.4$ to $V = 1.68$ causes w/a to increase by a factor of 1.4. (An increase of the V -value has far less influence on the beam size.) These changes of V translate directly into changes of w only if a is kept constant and V is changed by varying Δ . Now let us keep Δ constant and change V from 2.4 to 1.68 by decreasing the value of the core radius a . This change increases w/a by 1.4, which means that the beam width is actually decreased by a factor of 0.98. This example shows that a change of the core radius does not cause a proportional change of the beam width.

In the remainder of our discussion, we assume that the beam widths of the guided modes of both fibers joined by the splice are identical, $w_1 = w_2$. Figure 8 is a graph of (22) for a step-index fiber splice with $\lambda = 1 \mu\text{m}$, $n_2 = 1.457$, and $V = 2.4$. The figure illustrates how insensitive a fiber splice is to longitudinal separation of the fiber ends. However, this figure

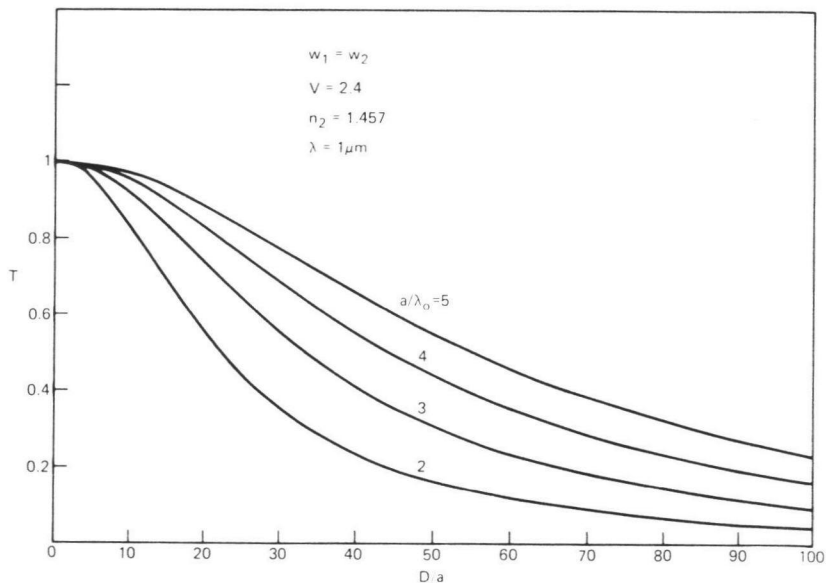

Fig. 8—Power transmission coefficient as a function of normalized longitudinal fiber displacement for identical step-index fibers. The curve parameter is the ratio a/λ of the core radius to free space wavelength.

was drawn under the assumption that both fibers of the splice are immersed in index-matching fluid. For splices in air, we must set $n_2 = 1$ in (22) and (23), which leads to lower values of T . The figure shows that larger core radii result in lower splice losses. However, it must be remembered that the figure is drawn for a fixed value of $V = 2.4$, fibers with larger core radii, thus have smaller values of Δ .

The transmission coefficients for tilts and offsets are gaussian functions of the tilt angle θ or the amount of offset d . Using normalized variables, $\pi n_2 w \theta / \lambda$ for the tilt and d/w for the offset, we can represent both cases in Fig. 9. For $w_1 = w_2 = w$ (27) simplifies to

$$\theta_e = \frac{\lambda}{\pi n_2 w}, \quad (33)$$

and the amount of offset (29) that causes T to drop to $1/e = 0.368$ of its maximum value reduces to

$$d_e = w. \quad (34)$$

We illustrate the meaning of these expressions with a specific example. Let $V = 2.4$, $\lambda = 1 \mu\text{m}$, and $\Delta = 0.002$ so that we obtain a core radius of $a = 4.15 \mu\text{m}$ for $n_2 = 1.457$. For the step-index fiber, we find from (8) or Fig. 2, $w/a = 1.1$ or $w = 4.56 \mu\text{m}$. (The corresponding value for the parabolic index fiber would be $w = 4.48 \mu\text{m}$.) The power transmission

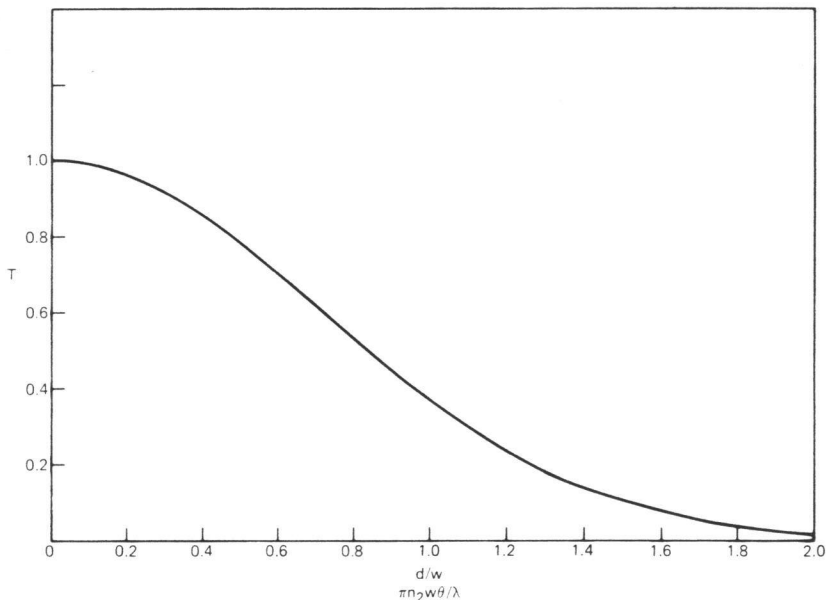

Fig. 9—Power transmission coefficient as a function of normalized offset or tilt angle.

coefficient would be $T = 0.368$ for $d = w = 4.56 \mu\text{m}$, or it would be $T = 0.9$ for $d = 1.5 \mu\text{m}$. If the axis of the fibers (joined by the splice) are laterally aligned, but if there is a tilt, a tilt angle $\theta = 0.048$ radians = 2.7° causes $T = 0.368$, while $\theta = 0.91^\circ$ reduces T from its maximum value to $T = 0.9$. A fiber with a narrower width parameter w would be less tolerant of offsets, but correspondingly more tolerant of tilts. This mutual relationship is expressed by the “uncertainty relation” (30).

V. CONCLUSION

Using the close match between gaussian beams and the field distributions of single-mode fibers, we have presented formulas and graphs for the power transmission coefficient of light through a fiber splice. The fibers on either side of the splice need not be identical. Splice losses occur for mismatched fiber parameters, transverse fiber displacement (offset), angular displacement (tilt), and longitudinal displacement⁶. All four cases have been discussed. Splice tolerances with respect to tilt and offset are mutually exclusive. This relationship has been expressed by an “uncertainty principle”.

The results presented in this paper are immediately applicable to the excitation of single mode fibers by gaussian-shaped laser beams.^{7,8}

REFERENCES

1. J. S. Cook, W. L. Mammel, and R. J. Grow, "Effect of Misalignment on Coupling Efficiency of Single-Mode Optical Fiber Butt Joints," *B.S.T.J.*, 52, No. 8 (October 1973), pp. 1439-1448.
2. H. Kogelnik, "Coupling and Conversion Coefficients for Optical Modes in Quasi-Optics," *Microwave Research Institute Symposia Series, 14*, New York: Polytechnic Press, 1964, pp. 333-347.
3. J. A. Arnaud, *Beam and Fiber Optics*, New York: Academic Press, 1976.
4. D. Gloge, "Weakly Guiding Fibers," *Appl. Opt.*, 10, No. 10 (October 1971), pp. 2252-2258.
5. D. Marcuse, *Theory of Dielectric Optical Waveguides*, New York: Academic Press, 1974.
6. D. Gloge, "Offset and Tilt Losses in Optical Fiber Splices," *B.S.T.J.*, 55, No. 7 (September 1976), pp. 905-915.
7. J. R. Stern, M. Peace, and R. B. Dyott, "Launching into Optical-Fibre Waveguide," *Electr. Lett.*, 6, No. 6 (March 1970), pp. 160-162.
8. D. Marcuse, "Excitation of the Dominant Mode of a Round Fiber by a Gaussian Beam," *B.S.T.J.*, 49, No. 8 (October 1970), pp. 1695-1703.